

USER GUIDE

TYPE B TROLLEY

MAN-M-0-112_10

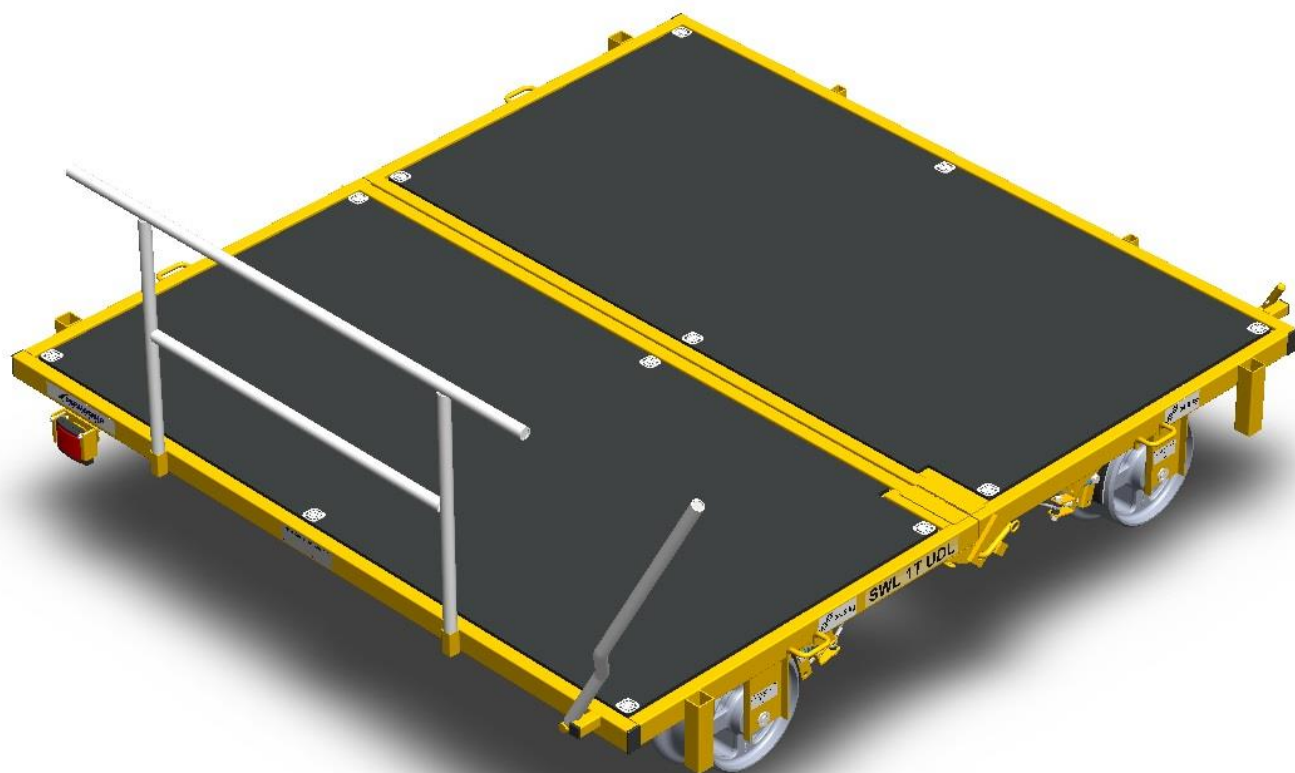

Hire from

PSM Plant & Tool Hire Centres Ltd

Head Office: 253-255 Blackfen Road, Blackfen, Sidcup, Kent DA15 8PR

Tel: 020 8850 5658 Fax: 020 8859 4377

Email: info@psmhire.co.uk www.psmhire.co.uk



MADE IN BRITAIN

CONTENTS

1. Introduction	4
2. Issue and Revision Record	5
3. Safe and Correct Use	6
4. Technical Specification.....	8
4.1 Physical Data for the Type B Trolley	8
4.2 Load Specifications	8
4.3 Operational Limits.....	8
4.4 Physical Data for the Type B Trolley Crane Attachments.....	8
4.5 Product Compliance.....	9
5. Storage and Transportation	10
5.1	10
5.1 Storage	10
5.2 Transportation.....	10
6. General Layout	11
7. Operating Instructions	12
7.1 Mounting on the Track	12
7.2 Loading the Type B Trolley.....	13
7.3 Using the Type B Trolley	13
7.4 Fitting the Red Light.....	13
7.5 Using the Crane Attachment (optional).....	14
7.6 Using the Type A/B Ramps and Straps (optional)	20
8. Maintenance.....	24
8.1. Wheels and Axles	24
8.2. Brakes	24
8.3. Type B Trolley Assembly	25
8.4 Red Light	25
8.5 Trolley Sides.....	25
8.6 Crane Attachment	25
9. Test Specification	27
10. Training	29
11. Ordering	30



Please note:

Whilst Permaquip Limited has taken every care in preparing this User Guide it is intended as a technical guideline only. Save to the extent that there are statutory rights to the contrary, Permaquip accepts no liability in relation to any use or reliance made of any information in this User Guide.

All information, illustrations and specifications in this User Guide are based on the latest information available at the time of publication. The right is reserved to make changes at any time without notice.

Equipment operators and installers shall be responsible for ensuring that a safe working environment and safe systems of work are in place and in certain circumstances advice and permission from the controlling authority must be sought before any operation, installation or surveying work is carried out.

Permaquip™ is a trademark of Permaquip Ltd.
©2006 Permaquip Ltd.

1. INTRODUCTION

The Permaquip™ Type B Trolley is designed to be used as a manual propelled, stand-alone load bearing rolling platform for use on-track.

Each Type B Trolley is equipped with a fail-safe braking system and is supplied with detachable Brake and Push Handles.

The Type B Trolley has been designed to be split into 2 halves to aid handling and transporting to and from site.

Any modifications or enhancements made by the user or third party which have not been approved by Permaquip are not recommended. Any modifications to the equipment will become the responsibility of the user or third party and the warranty with Permaquip will become null and void. Please see Permaquip's T&Cs on our website for further details.

Prior to using the Type B Trolley, Permaquip advise all operators and personnel to familiarise themselves with the product. If required Permaquip product familiarisation training.

2. ISSUE AND REVISION RECORD

This document will be updated when necessary, by the re-issue of the complete document.

Issue	Description	Date	Revised Page No.	Revised By.
08	Format updated, issue and revision record added, red light fitting detail amended.	23/05/2016	All	M.S.
09	Maintenance updated.	06/11/2017	18 and 20	M.S.
10	Crane attachment section updated. Ramp attachment section added.	21/11/2019	6, 11-29	M.S.
-	Formatting and Permaquip branding updated.	28/04/2021	All	M.S.
-	Permaquip address updated.	15/03/2022	All	J.F.

Authorised By:	Martin Sheppard BEng	
	Engineering Manager	

3. SAFE AND CORRECT USE

Please keep this Manual for future reference.

To ensure safe and correct use of the Type B Trolley the following should be noted:



Wear eye, feet, head and hand protection when using the Type B Trolley. Additional Personal Protective Equipment (PPE) should be worn according to local regulations and government guidelines.



The Type B Trolley, or parts of, must be replaced if damage occurs with genuine Permaquip parts. Do not use the Type B Trolley if any components are damaged.



Store the Type B Trolley safely and in a secure position to prevent inadvertent damage.



Before using, always undertake a Manual Handling Risk Assessment and follow the assessment guidelines. Use the handles provided as detailed in this manual. Do not exceed walking pace, noting underfoot conditions. Do not walk on sleepers or the rail head. Reduce the walking pace on gradients.



Always ensure there is enough trained personnel present to operate the Type B Trolley as detailed later in this manual. Under no circumstances should fewer staff be used.



Ensure both halves of each trolley have the same serial number. Ensure they are kept together as one unit.



The Type B Trolley has a SWL of 2000 Kg. (Restricted to 1000kg on certain infrastructures) Under no circumstances should this be exceeded. The load must be uniformly distributed to ensure stability. Permaquip approved Load restraint straps and deck side systems should be used to assist security of the load. It is the operator's responsibility to plan the load of the Type B Trolley considering all the above factors.



Loads that impair the operator's vision when moving the trolley, encroach into the operator's travel position or exceed the gauge profile should not be carried.



The Type B Trolley is designed for manual propelling only and must not be propelled using a powered vehicle.



Do not hold / tie off the Brake Handles using mechanical means. Tampering with brakes puts lives at risk!



The Type B Trolley is not permitted to be used outside of a possession.



Do not ride the Type B Trolley or items being carried by it. Riding the Type B Trolley puts yourself and others at risk.



Do not use the Type B Trolley for any other purpose than as described in the introduction. Please contact Permaquip Ltd for advice on use for other applications or purposes.



Do not allow any load protrusions to face downwards such that any load could interfere with the braking mechanism.



During transit, the Type B Trolley should be secure and kept away from all electrified lines. The Type B Trolley fitted with insulated wheels must not be used in locations where live AC overhead power lines are present. Do not use the Type B Trolley near live DC third-rail or fourth-rail systems.



Before placing on track ensure the Type B Trolley has been maintained and perform a COP0018 pre-use check. Failure to do so may result in injury, damage to equipment or infrastructure, consist runaway or worse.



Stopping distances will be greatly increased by icy or wet conditions; gradients; an increase in load; an increase in speed.

4. TECHNICAL SPECIFICATION

4.1 Physical Data for the Type B Trolley

	Type B Trolley (Standard)	Type B Trolley (LUL)	Push Handle	Brake Handle	Trolley Sides
Width	1800 mm	1800 mm	1220 mm	145 mm	1785 mm
Length	1940 mm	1940 mm	25 mm	25 mm	1815 mm
Height	335mm	335mm	600mm	865mm	335mm
Total Mass	128 kg	133 kg	5 kg	1.5 kg	24 kg
Centre of Mass	Central	Central	Central	Central	Central

4.2 Load Specifications

- Maximum load capacity for one Type B Trolley: 2000 kg UDL¹
- Maximum total load capacity when Trolley Sides are fitted: 1976 kg UDL¹

¹ Note that all loads up to and including the maximum shown should be uniformly distributed. The load must be positioned equally about the Trolley centre(s). Loads should be planned according to staffing levels and track conditions. When used on Network Rail or LUL infrastructure, the maximum SWL is 1,000 kg UDL. Please refer to CoP0018 for guidance on recommended staff depending on track gradient and load.

- Maximum load capacity of the Crane Attachment (when fitted): 420 kg SWL
- Permaquip Type A/B Ramps and Straps, (per pair and when fitted)
 - Maximum ramp inclination: 30% / 16.5°
 - Max. axle load for 1.6m or over wheelbase vehicles: 1500 kg
 - Max. axle load for 0.8m wheelbase vehicles: 750 kg
 - Max. mass of tracked vehicles with over 1m ground contact length: 1500 kg

4.3 Operational Limits

- Maximum gradient: 1:30
- Maximum cant (on track): 150 mm
- Maximum speed: 5 km/h (walking pace)

4.4 Physical Data for the Type B Trolley Crane Attachments

	Crane Attachment	
	Type B Standard	Type A/B Side
Model		
Width	350mm	350mm
Length (including Clamp screw)	2045mm	1910mm
Height (from trolley deck)	1080mm	1080mm
Total Mass	68kg	67kg
Mass of heaviest component	36kg	35kg

- Red Light Replacement Batteries



3v DC
2 qty. Size AA (LR6, 15A, KAA, X/E91,
MX/MN1500, 815, AM3, 4206/4006)
Ø14.5 mm x 50.5 mm nominal dimensions
1.5v DC, Alkaline
Mercury and cadmium free

4.5 Product Compliance

The standard Type B Trolley complies with RIS-1701 and BS EN13977.

5. STORAGE AND TRANSPORTATION

5.1 Storage



The Type B Trolley and any associated spare parts should be stored in a dry and secure environment. Safety critical spare parts must be stored in a dry, secure and controlled environment.



The maximum number of Type B Trolleys that can be stacked during storage is 8.

5.2 Transportation



During transit, the Type B Trolley should be secured and kept away from all electrified lines. Ensure that any method used to secure the Type B Trolley in/on a vehicle applies the load uniformly and does not exceed the SWL. Do not use excessive force when using a ratchet type loading strap. Two Retaining/Lifting Hooks are provided each side for use during transit. These can be used to retain the Type B Trolley and for lifting with suitable lifting equipment.

If the two halves are separated for transit, ensure that no damage occurs to the brake mechanism or frame.



The maximum number of Type B Trolleys that can be stacked during transit is 5, provided that this is within the vehicles operating capabilities. Note that the load must be secure and stable.

6. GENERAL LAYOUT

The following shows the main components of the Type B Trolley

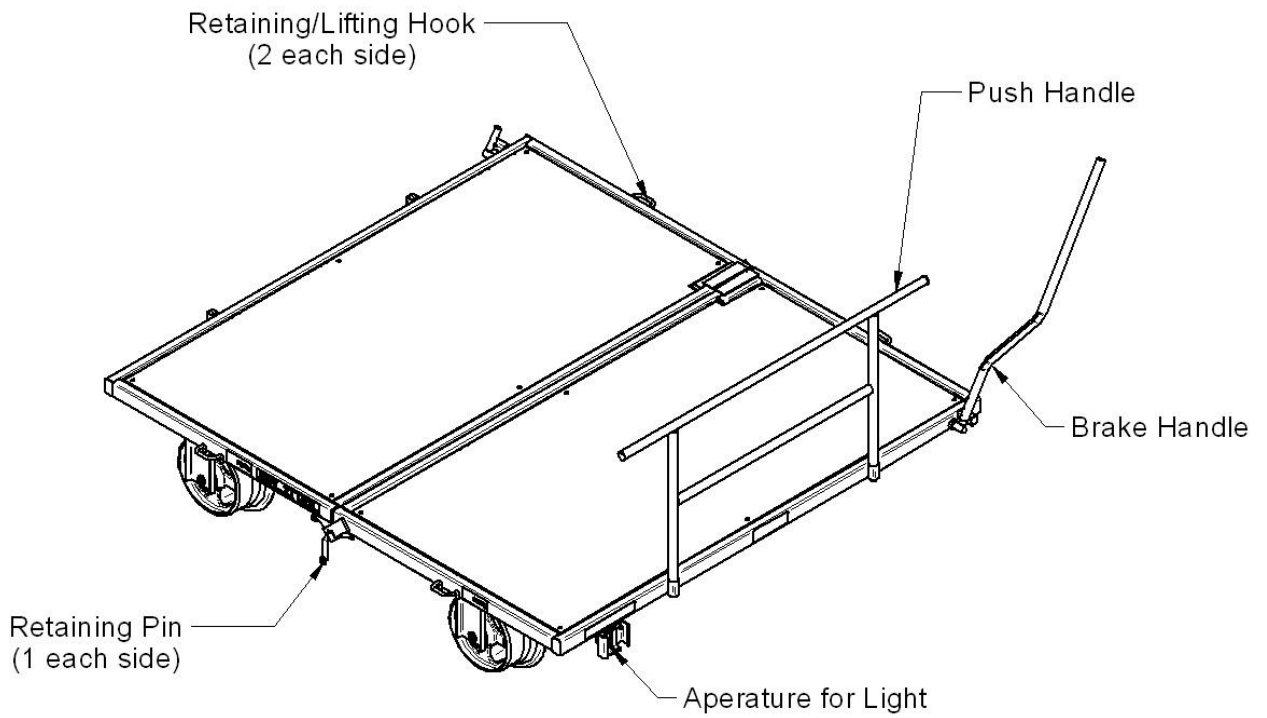

7. OPERATING INSTRUCTIONS

The following procedure outlines the correct method for operation.



Always push, never pull, the Type B Trolley.



All work should only be performed by competent personnel.



Always follow local regulations.



Observe Manual Handling Regulations.

7.1 Mounting on the Track

1. It is recommended that the Type B Trolley is lifted by four persons.
2. Check that both Type B Trolley halves have the same serial number, are identified with the SWL and the 'Next Brake Test Due' has not expired.
3. Check that the brakes are in good working order. To do this, access the braked wheels and rotate with one hand. The wheels should resist movement. If in doubt do not use until it has been checked by a competent person.
4. Assemble the two halves on firm level ground or on the track by standing both halves onto their wheels, with the locating lugs facing each other. Bring both halves together whilst interlocking the brake locating lugs. Once together push both Retaining Pins fully into both halves and rotate so the Pin is locked in position, as shown below.



Trolley Halves Mated Locked

5. Ensure that all four wheels are in contact with the rail head.

6. Fit the Brake Handle and Push Handle onto the Type B Trolley at the opposite end to the intended direction of travel.
7. Check the brakes are working correctly – they are fail-safe so should be on when the Type B Trolley is stationary.

7.2 Loading the Type B Trolley

1. Ensure that the SWL is not exceeded. Note that the SWL is reduced when the accessories such as Trolley Sides or Crane attachments are fitted.
2. Ensure that the load is stable and is uniformly distributed over the Type B Trolley loading area.
3. Ensure that the load does not overhang the Type B Trolley sides and infringe on the track gauge.
4. Ensure that loads do not over-hang where they may impair the operation of the brakes.
5. Ensure that load do not impair the operator's vision when moving the trolley or encroach into the operator's travel position.

7.3 Using the Type B Trolley

1. Move the Brake Handle sideways to release the brakes and use the Push Handle to move the trolley.
2. Releasing the Brake handle will then re-apply the brakes.

7.4 Fitting the Red Light

1. The Red Lights are in two positions on the Type B Trolley. There are no additional fixings required as they slot into the light brackets fitted within the apertures, as shown below. The two locking screws supplied with the light bracket can be fitted to prevent unauthorised removal.



Red Light (Fitted)

- The Red Lights can be switched from underneath using the on and off switch positioned between the support tabs. It will need to be actuated using your fingernail or a small thin flat object. Operation has purposely been made difficult to prevent false operation.

7.5 Using the Crane Attachment (optional)

The following procedure outlines the correct method for operation.



Wear eye, feet, head and hand protection when using the crane attachment. Additional Personal Protective Equipment (PPE) should be worn according to local regulations



Ensure any slings or lashing straps to be used are suitable and that valid test certificates are available.



Before attempting to lift a load, ensure that all component parts of the crane are properly assembled.



Before attempting to lift a load, ensure that the trolley is securely strapped down to the rail.



Only freely suspended loads are permitted.



When the trolley is in motion, the crane must be stowed in its travelling position.



Ensure familiarity with all controls before attempting to operate the crane.



All work should only be performed by competent personnel.



Always follow local regulations.



Observe Manual Handling Regulations.



Do not commence slewing until the load is suspended.



Do not stand under any suspended load or within the crane's slewing range.



Do not leave the crane or move the trolley with a suspended load.



Do not attempt to overload the crane.

Crane Attachment variants for the Type B Trolley

- 28810 Swinglift Crane to Suit Type B Trolley c/w Straps
- 38378 Swinglift Crane Type A / B Trolley Side Fitting c/w Straps

Attachment of the Crane Attachment to the Type B Trolley

1. Ensure that all of the components are available.
2. Check crane, rope and attachments for any obvious signs of damage. The crane must not be used if any damage to the rope is apparent.
3. It is recommended that the Crane Attachment is assembled by two persons to help lifting awkward loads and reduce risk of damaging equipment.
4. Strap the Type B Trolley to the rail, using the straps included with the crane attachment, as shown below.

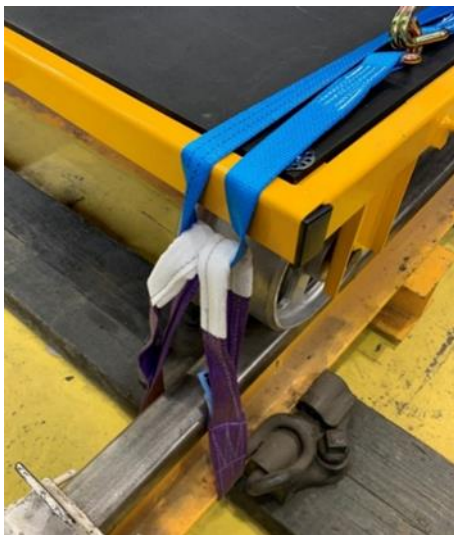

5. Mount the Crane Attachment base to the Type B Trolley, as shown below.



Side Fitting Crane Attachment Base



Standard Crane Attachment Base

- Secure the Crane Attachment base to the Type B Trolley by turning the threaded handle, as shown below.



Crane Base (Clamped to Trolley)

- Mount the Crane Attachment arm onto the base, as shown below.



Side Fitting Type A and B Crane



Standard Type B Crane

8. Ensure that the locking pin is located properly to prevent the crane from unintentionally slewing, as shown below.



Locking Pin (Locked)

Lifting a Load with the Crane Attachment

1. Release the locking pin and place it in its stowing position, as shown below.



Locking Pin (Released)



Crane Positioned Over Load

2. Position the crane over the load to be lifted as shown above.
3. Connect the correct lifting equipment to the crane hook in accordance with the manufacturer's instructions.

4. Lift the load by turning the winch handle in the direction specified at the base of the handle, as shown below.



Lifting Load

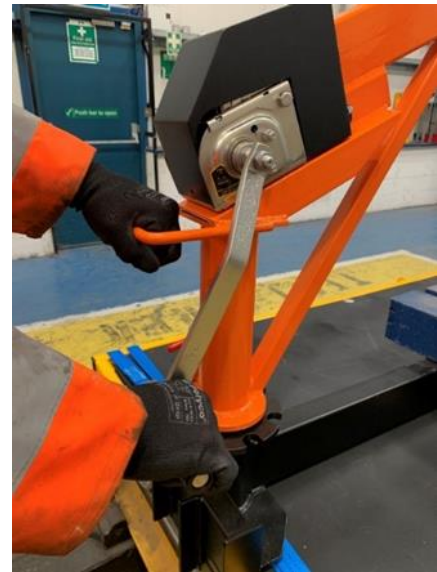

Slewing Load

5. Once the load has been lifted to the correct height, the crane can slew and the load lowered into position on the deck of the trolley, as shown below.

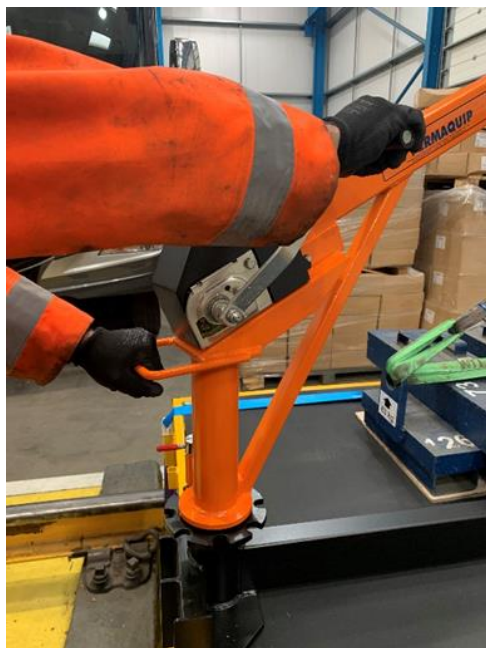

Lowering Load



Lowered Load

6. The crane can then be locked in its stowed position and the straps can be released from the rail and stored safely on the trolley. The Trolley can now be moved along track with its cargo.



7.6 Using the Type A/B Ramps and Straps (optional)

The following procedure outlines the correct method for operation.



Wear eye, feet, head and hand protection when using the crane attachment. Additional Personal Protective Equipment (PPE) should be worn according to local regulations



Ensure slings and lashing straps to be used are suitable and undamaged.



Ensure support jacks, ramp attachments and ramps are present and undamaged.



Before attempting to load the ramps or trolley, ensure that all components have been assembled and secured in accordance with this user guide.



All equipment should be stowed safely prior to moving the trolley.



Ensure familiarity with all equipment and limitations before attempting to use the loading ramps.



All work should only be performed by competent personnel.



Always follow local regulations.



Observe Manual Handling Regulations.



Do not load the ramps until the trolley has been securely strapped down and supported.



Do not attempt to overload the ramps or trolley.

Loading ramps, attachments and straps for the Type A / B Trolley / Trailer

- 38730 Type A/B Ramps and Straps

Attachment of the Loading Ramps to the Ends of the Trolley / Trailer

1. Ensure that all of the components are available.
2. Check all components for any obvious signs of damage. The loading ramps must not be used if any components are damaged.
3. Depending on the equipment being loaded using the ramps, the deck should be protected from damage and fitted with a board or boards to help distribute (spread) the load across the deck. Plywood boards etc...

4. Once the trolley is positioned, strap the trolley to the rail, using the double ratchet lashing strap and webbing slings across the centre section of the trolley close to where the two sections join, as shown below. Do not over tighten the strap. The webbing slings should wrap around the rail.
5. The short length of straps on the ratchet should pass through the sling loops and connect to the bottom of the ratchets. The plain strap will run along the trolley deck and be tightened through both ratchets either side of the trolley.
6. Position the support jacks either side under the trolley frame at the end where the ramps will be positioned. The jack should rest on the rail head and be jacked to support the chassis. Do not over jack and lift the trolley wheels from the track. See below.



7. Measure the track of the vehicle wheels and position the ramp attachments onto the end of chassis centred with vehicle track. Note that due to welded sections of the chassis the positioning of the attachments is limited and should be negotiated to the best possible safe position.
8. Hook the ramps onto the attachments and where possible adjust the lateral position to best suit the vehicle track.

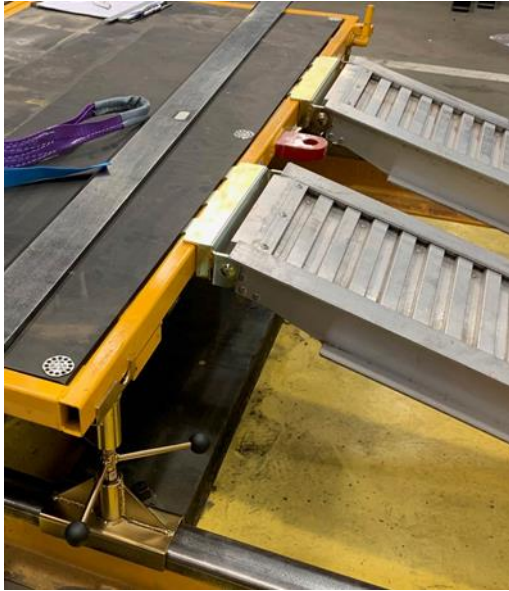

9. Load or unload the trolley using the ramps. Ensure the SWL is not exceeded refer to the label on the ramps or the load specification section of this user guide.
10. Once loaded / unloaded the ramps and attachments can be removed, the support jacks can be released, and the straps can be released. All parts should be stored safely. The trolley can then be moved along track.

Attachment of the Loading Ramps to the Sides of the Trolley / Trailer

1. Ensure that all the components are available.
2. Check all components for any obvious signs of damage. The loading ramps must not be used if any components are damaged.
3. Depending on the equipment being loaded using the ramps, the deck should be protected from damage and fitted with a board or boards to help distribute (spread) the load across the deck. Plywood boards etc...
4. Once the trolley is positioned, strap the trolley to the rail, using the double ratchet lashing strap and webbing slings across the opposite side section of the trolley to where the ramps will be fitted, as shown below. Do not over tighten the strap. The webbing slings should wrap around the rail. The short length of straps on the ratchet should pass through the sling loops and connect to the bottom of the ratchets. The plain strap will run along the side of the trolley deck and be tightened through both ratchets either end of the trolley.



5. Position the support jacks either side under the trolley frame at the ends where the ramps will be positioned. The jack should rest on the rail head and be jacked to support the chassis. Do not over jack and lift the trolley wheels from the track. See above.
6. Measure the track of the vehicle wheels and position the ramp attachments onto the side of chassis centred with vehicle track. Note that due to welded sections of the chassis the positioning of the attachments is limited and should be negotiated to the best possible position.
7. Hook the ramps onto the attachments and where possible adjust the lateral position to best suit the vehicle track.

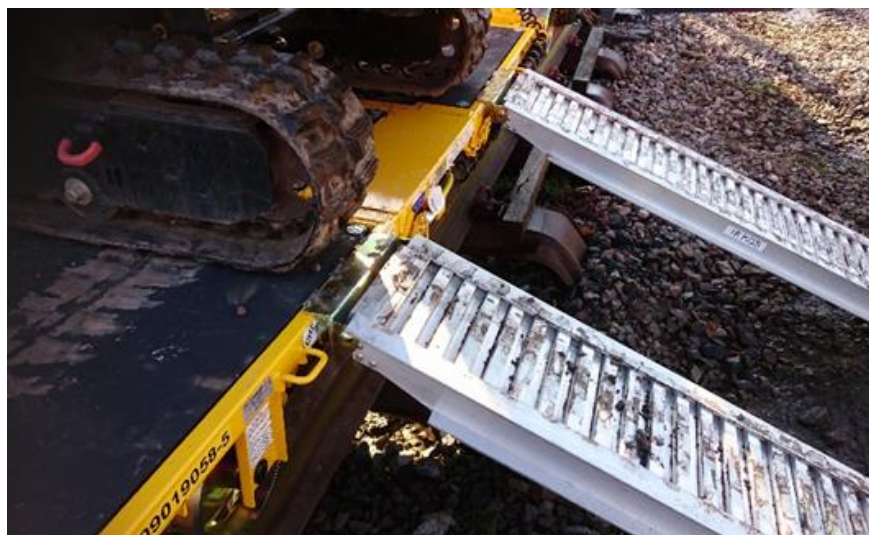

8. Load or unload the trolley using the ramps. Ensure the SWL is not exceeded refer to the label on the ramps or the load specification section of this user guide.
9. Once loaded / unloaded the ramps and attachments can be removed, the support jacks can be released, and the straps can be released. All parts should be stored safely. The trolley can then be moved along track.

8. MAINTENANCE



All work should only be performed by competent personnel.



Always follow local regulations.



Observe Manual Handling Regulations.



Brake tests must be performed following any repair or replacement of the brake system or components, including brake pad replacement.

For components that require replacing please refer to the Type B Trolley Spare Parts List. Please contact Permaquip Ltd for additional copies.

Note that:

- **The Maintenance and Testing of the Brakes, Wheels and Axles are defined as Railway Safety Critical under CoP0010, Railway Safety Critical Maintenance Elements of Small Plant and Equipment.**
- **The Maintenance and Testing of the Brakes are covered under CoP0018, Rail Mounted Manually Propelled Equipment. The brakes must be maintained and tested at a periodicity of no greater than 3 months.**

8.1. Wheels and Axles

1. With the brakes released using the Brake Handle, check the wheels rotate freely.
2. Resistance to rotation or rocking of the wheel on the axle indicates either a worn axle or a cracked bearing. The wheel bearings are sealed for life and do not require lubrication. There should be no more than 2.0mm end float of the wheels.
3. Check the wheel profile for wear, cracks or damage. Replace damaged or worn wheels.
4. Check the Axle Retaining Pin is securely in place.

8.2. Brakes

1. Remove the brakes and check the brake linings. Remove any dirt or oil from the working surfaces. The recommended minimum thickness of the brake pad lining is 2.5mm.
2. Check the operation of the brake to ensure that the brake rod, mechanism and adjusters are in good condition.
3. Lubricate all brake pivot pins, brake rod and adjusters with a general-purpose lubricant.
4. Check that both brake shoes apply and release simultaneously. The adjusting screw enables this to be achieved. Once both brakes are in contact with their wheels, the cable should have no tension.
5. Test the brake efficiency using the Brake Test Tool. Ensure that the wheels and brake pads are dry. The brakes should be tested at all four quadrants of each braked wheel and in both directions. The average torque at which the wheel resists movement should be equal or greater than 80 Nm.
6. If the brake torque is not achieved, check and adjust the brakes as described previously and repeat the tests.

7. Fix a 'Next Brake Test Due' label onto the Trolley. The date specified must be within 3 months. Complete the Maintenance Brake Test Record Sheet.

8.3. Type B Trolley Assembly

1. Check that the frame structure is free from deformation and that all welds are in good condition.
2. Ensure that the axle mounts are straight and are in-line.
3. Mount the Type B onto the test track. Check the chassis is flat by ensuring that the maximum gap between one-wheel face and rail head is 2mm.
4. If the chassis is bent or twisted, place the unladen trolley on a flat test track or smooth flat level surface. Use a straight edge over the chassis frame, a maximum of 10mm bend or twist over the entire chassis is allowed assuming that the wheels are within the maximum 2mm rock tolerance.
5. Check that the brake rod and chain/cable assemblies are in good condition.
6. For standard Type B Trolleys fitted with wooden decks, check the condition of the wood. Decks that are loose, de-laminated, cracked or have holes need to be replaced.
7. For LUL Type B Trolleys fitted with aluminium decks, check the condition of the aluminium. Decks that are loose, damaged or deformed need to be replaced.
8. Check that the Retaining/Lifting Hooks are in good condition, that they are fit for purpose and that the lifting SWL label is fitted next to each of the Hooks.

8.4 Red Light

1. To replace the batteries within the Red Light, remove the 4 off cross-headed screws from the rear of the light assembly and lift off the rear cover.
2. Replace the 2 off batteries to the correct specification, noting the polarity.
3. With the gasket in position replace the rear cover and secure using the 4 off screws.
4. Discard the old batteries according to local and national regulations.
5. Check the light operation using the slide switch on the rear cover.
6. Replace into the Type B Trolley.

8.5 Trolley Sides

1. Place both of the long Trolley Sides along the length of the assembled Type B Trolley so that the Side Supports are resting in the Trolley Retaining Hooks. Move the Antiluce Retaining Pins into the horizontal position.
2. Place one of the short Trolley Sides at one end of the Trolley and locate onto the long trolley Side.
3. Secure in position by moving the Antiluce Retaining Pins to the vertical position.
4. Repeat for the other end.

8.6 Crane Attachment

To ensure safety and reliability, the following inspection/servicing procedures should be applied when in use:

- Check that the main components have no deformation or cracks.
- Check that the movement of the clamping components is smooth and free from sticking.

- 
- Lubricate the clamping screw thread.
 - Lubricate the join between the two main components to allow smooth slewing.

9. TEST SPECIFICATION

The Type B Trolley should be tested to the following specification after the Maintenance procedures have been completed where necessary.

Note the testing of the Brakes is defined under the Maintenance section of this User Guide. This is important as the brakes must be checked and maintained before testing.

The Type B Trolley should be tested to the following specification after any structural repairs have been carried out, or when the Type B Trolley has been damaged.

1. Note the Serial Number of the Type B Trolley (note that both halves have the same serial number).
2. Mount the Type B Trolley onto a test track and ensure the brakes are on.
3. Measure the height between the track and the centre position of the Type B Trolley frame on all four sides.
4. Lower a 2,500kg calibrated test mass onto the trolley (1.25 x 2,000kg SWL). Move the trolley approx. 2m on the track and return to the same position.
5. Remove the mass and re-measure the heights. There should be no more than 1.5mm difference between the two measurements.
6. Check that there is no deformation or weld damage. If there is, reject the trolley and check all units from the batch.
7. Lower a 172.5 kg UDL test mass onto the trolley.
8. Lift the Trolley with test mass by the 4 trolley lifting hooks using a 4 leg sling assembly.
9. Lower the Trolley and remove the test mass.
10. Check that there is no deformation or weld damage.

The standard Type B Trolley should also be tested to the following specification.

1. The conductivity between the wheels and frame of the Type B Trolley needs to be checked using a calibrated resistance meter.
2. Zero the meter so the display reads 0.00 Ω .
3. Connect one lead to an unpainted section of the Type B Trolley frame. Connect the other lead to one of the wheels. The measured resistance should be less than 0.15 Ω .
4. Repeat for the other wheel and other trolley half.

The LUL Type B Trolley and other Type B Trolleys fitted with insulated wheels should also be tested to the following specification.

1. The resistance of the insulation of the Type B Trolley needs to be checked using a calibrated resistance meter.
2. Ensure the brakes are on.
3. Check that the meter display reads 1 Ω or less when the two leads are connected together.
4. The resistance between the trolley frame and wheels needs to be checked. Connect one lead to an unpainted section of the Type B Trolley frame. Connect the other lead to one of the wheels of the same trolley half. The measured resistance should be at least 5 M Ω .
5. Repeat for the remaining three wheels and record the four measurements taken.
6. The resistance between the wheels needs to be checked. Connect one lead to one of the wheels. Connect the other lead to the opposite wheel that sits on the opposite rail head of the same trolley half. The measured resistance should be at least 5 M Ω .

7. Repeat for the remaining pair of wheels and record the two measurements taken.

The Crane Attachment should be annually tested to the following specification after Maintenance procedure has been completed.

Lifting equipment should be inspected, maintained and tested by a competent person in accordance with statutory requirements.

1. Visually check that there is no component damage or distortion.
2. Mount the Crane Attachment onto a Type B Trolley as described in section 6.5 of this manual.
3. Using the correct lifting equipment, lift a test weight of 525 kg (1.25 x SWL) clear of the floor.
4. Maintain this load for a period of 10 minutes.
5. Slew the test weight through the full slewing arc of the Crane Attachment
6. Check all components to ensure there is no weld cracks, permanent deformation, paint flaking or damage which has resulted from the test.
7. Inspect all straps for excessive wear or signs of potential failure, replace if necessary.
8. Test all other lifting equipment in accordance with current legislation.

Permaquip Ltd offer a testing and maintenance service – please contact us for further details.

10. TRAINING



Persons that will operate, maintain, and test the Type B Trolley should undertake a programme of training. This programme of training should include the following aspects:

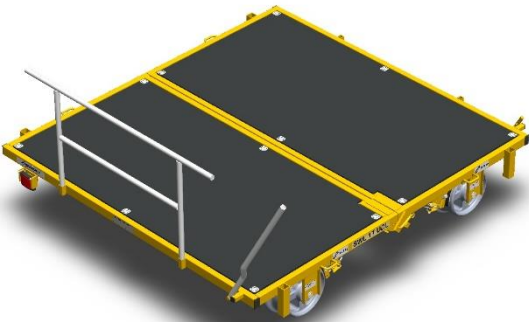
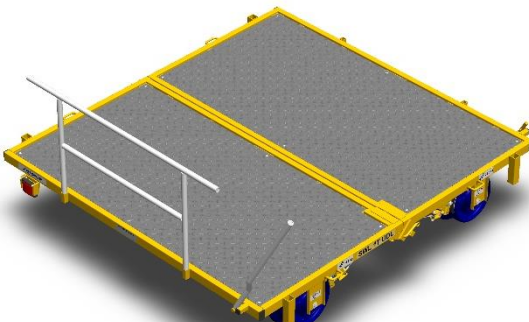
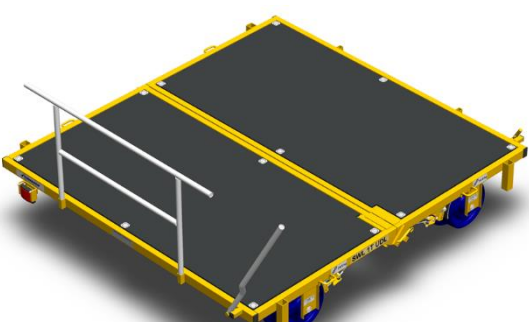
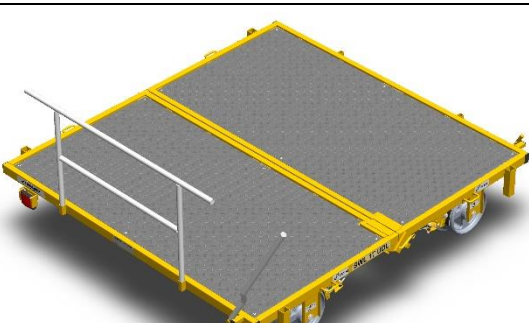

- Product familiarisation.
- Component location and function.
- Product preparation.
- Safe and Correct Use.
- Maintenance.
- Testing.
- Practical experience.

Permaquip Ltd offer a training service – please contact us for further details.

11. ORDERING

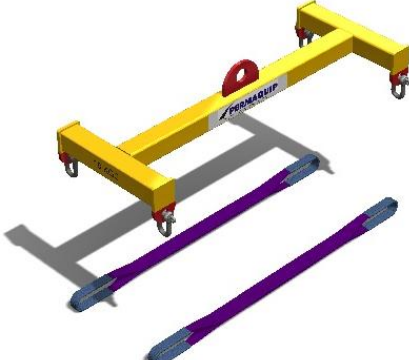
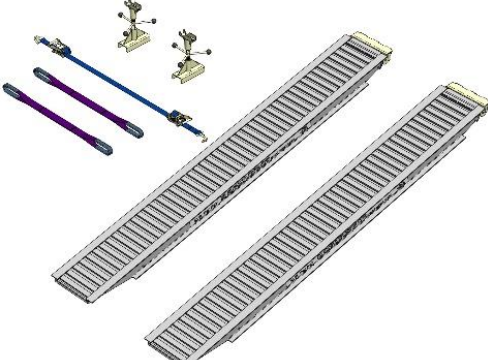
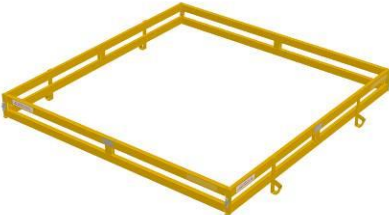
	DESCRIPTION	PADS Cat. No.	PART NO
Type B Trolley Standard (Wood top with non-insulated wheels)		068/019193	24681
Type B Trolley LUL (Aluminium top with insulated wheels)		-	27791
Type B Trolley (Wood top with insulated wheels)		-	27789
Type B Trolley (Aluminium top with non-insulated wheels)		-	27790

Swinglift Crane to Suit Type B Trolley c/w Straps		-	28810
Swinglift Crane to Suit Type A or B Trolley Side Fitting c/w Straps		-	38378
Points Motor Crane Sling		-	39223
Type A/B Ramps and Straps		0068/019194	38730
Trolley Sides		068/019188	33043

<p>Gas Bottle Carrier Assembly</p>			<p>GBC05</p>
<p>Permaquip P1 Wheel Profile Gauge</p>			<p>38898</p>
<p>Wheel Profile Wear Gauge</p>			<p>34596</p>
<p>Red Light</p>		<p>068/011260</p>	<p>040820218</p>
<p>SafeGrip – Type B - Set</p>			<p>SGB-01</p>



For spare parts please see the Type B Trolley Spare Parts List.

Please contact Permaquip Ltd for further information and support.

Our contact details are shown on the front of this User Guide.

In order to avoid delay and to have your orders fulfilled promptly,

Please telephone, e-mail, fax or write giving the following information:

- 1. Company name.**
- 2. Contact details.**
- 3. Invoicing and delivery details.**
- 4. Purchase order number.**
- 5. Method of delivery.**
- 6. Part number, description, and quantity for each item.**